

44" Ratchet Clamp

Product Information (RO)



Key Points:

- Designed for use on 44" pipe
- Inside diameter of clamp pads are machined to enable snug fit with pipe
- Heavy duty steel clamps made from steel rolled 'the hard way' to produce extreme rigidity
- Seal welded construction provides years of service
- Clamp is operated by Acme-threaded screw
- Excellent clamping pressure due to alloy screw, rigid construction, and bored pads
- Sold with reversible ratchet wrench
- Ring spacing enables easy access to pipe joint
- Clamp inside diameter is sized 1/8" larger than nominal pipe diameter

Before use, read the disclaimer below



PRODUCT DETAILS

Part #: KC-44-R

Weight: 381 lbs (172 kg)

Clamp Material: A36 Carbon Steel

Screw Assembly
Screw: A311
Material: Nuts: C1018

Ratchet Type: Square Head, 1"

Ratchet Part #: KC-RH-17-1.000

Screw assembly
part number: KC-SC-44+

Grease type: NLGI GC-LB

Operating temp
range: -13° F (-25° C) to
+122° F (+50° C)

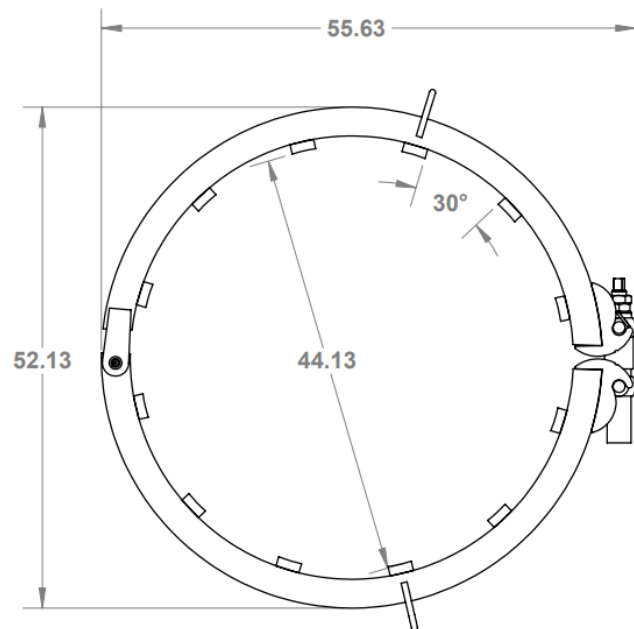
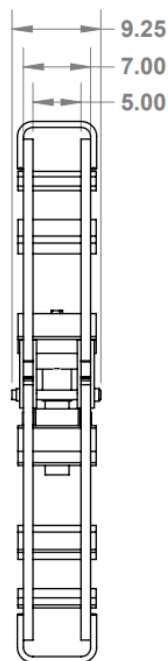

WARNING! 1. Do not use the K.C. alignment clamp as a lifting device. 2. K.C. alignment clamps are not to be used as a load bearing device. 3. A lift mechanism should not be attached to the clamp to lift the pipe. 4. Wedges should not be driven under the frame of the clamp in an attempt to reform the pipe as it may damage the clamp and void the warranty. 5. The clamp is not designed for the alignment of the tees, elbows, valves and other fittings. 6. The clamp should not be used with any type of device that is used to preheat the pipe prior to welding as this may result in failure of the clamp. 7. Do not use a mechanical advantage (such as a cheater bar) on the end of the ratchet handle.